

## **For the West Somerset Amateur Radio Club**

### **VX-7/5R Computer Interfacing by Bas Helman G4TIC**

#### **Introduction**

Having recently acquired a Yaesu VX-7R handheld with a heavyweight manual and a complex and laborious data entry procedure I sought an easier option. By using the rig's Clone facility it is possible to download pre-prepared, but editable, lists of memory data including repeaters, offsets, CTCSS tones, broadcast and other bands from files posted on the Internet to the rig via a computer to PC linkage. In addition it is possible to alter the rig's frequency coverage for use when travelling abroad.

There is a commercial package available consisting of a customised lead and software but this costs between £40-50 and doesn't allow band adjustments. There are free software packages available for download which do the same job and more so the problem reduces to providing the interface cable. The software I chose to use is VX-7 Commander V 1.3.3 by Jim Mitchell KC8UNJ available from <http://mywpages.comcast.net/sllewd/vx7rmain.htm> then select the [PC Hardware] link.

Whilst there are a number of interface circuits available on the internet these are generally designed for the VX-5R. Fortunately the circuit required is the same for both rigs but the plug required for the VX-7, a four section jack with a screw in fitting to preserve the water tight feature of the rig, is unavailable as a separate commercial product. I tried to cobble a jack together from a standard four section plug but as I filed it down to the necessary diameter it fell apart. No one said amateur radio should be easy! The solution was to buy Yaesu's accessory breakout lead the CT-91. A similar product can be had for the VX-5R, the CT-44, but a standard four section jack would probably work plugged directly into this rig as there is no need for the screwed section.

The next problem was to choose a circuit to convert from the RS232 voltages to those of the rig. So far I have tried three circuits one with no success another with partial success (it communicated in one direction only) and the one documented here with complete success. Testing continues on these problem circuits and any break-through will be reported at a later date.

What follows is my attempt to collect together in a single document the essential information for completing the project. I have provided a matrix board layout for the chosen circuit and, hopefully, some encouragement and tips for the reluctant or novice home constructor.

## The Circuit

The circuit I have used is a six transistor design with a number of desirable features:

- The components are cheap and readily available
- The circuit is powered from the computer's RS232 interface so no separate power supply is required
- As it is constructed from discrete components it is both easy to test and to maintain.

## The Circuit Design

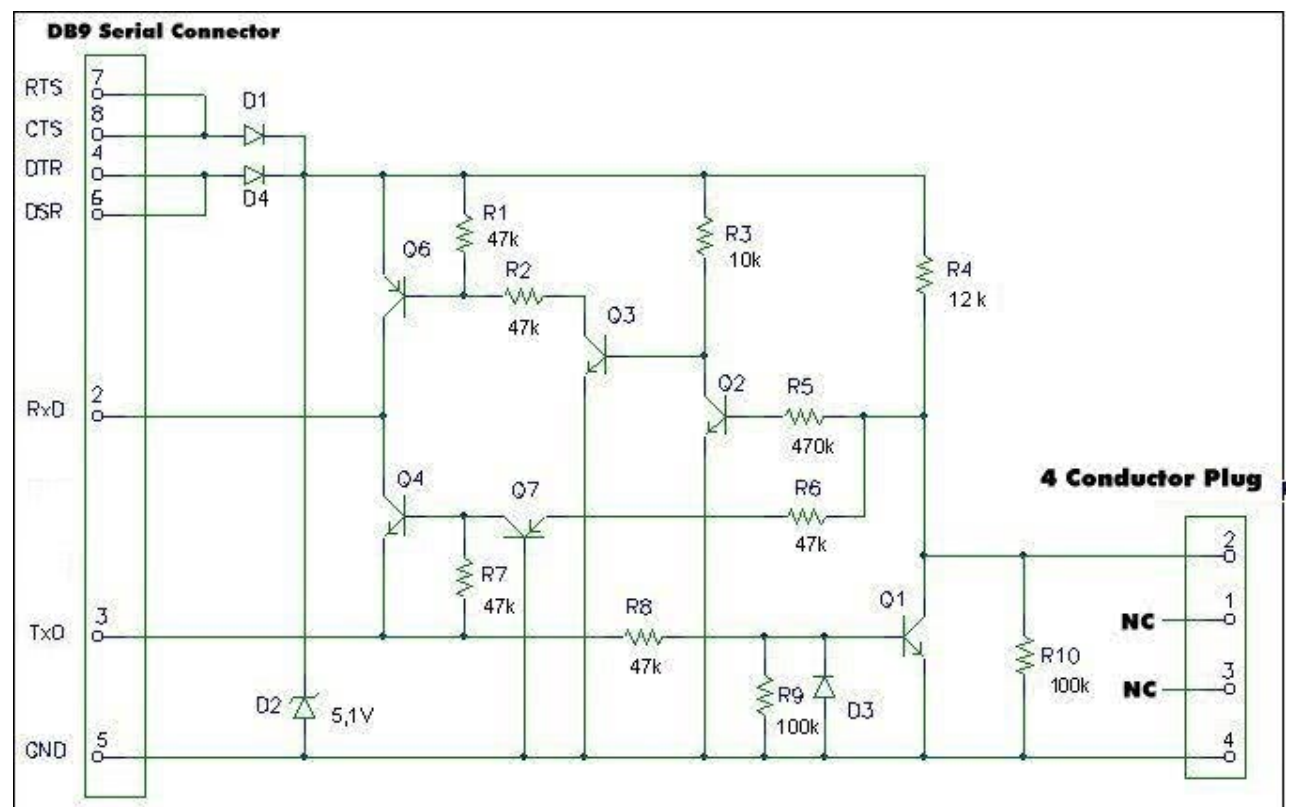

## The Matrix board Layout

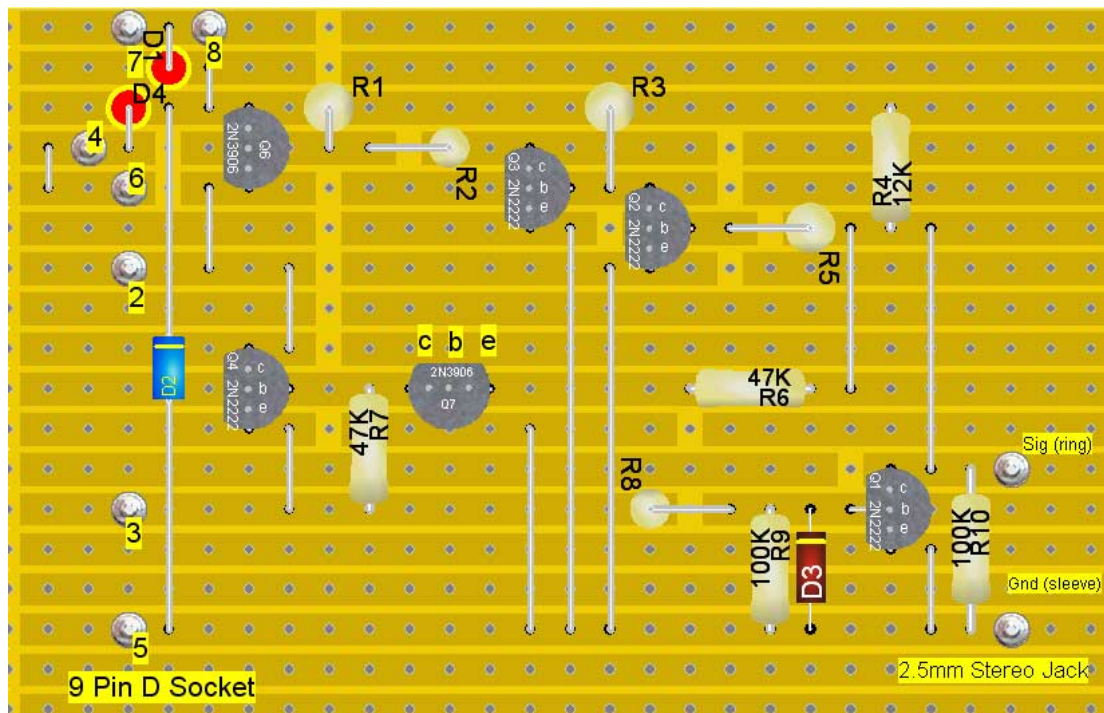

The layout was compressed to fit into an aluminium “u” box measuring 75x50x25mm.

## The Solder side of the Board

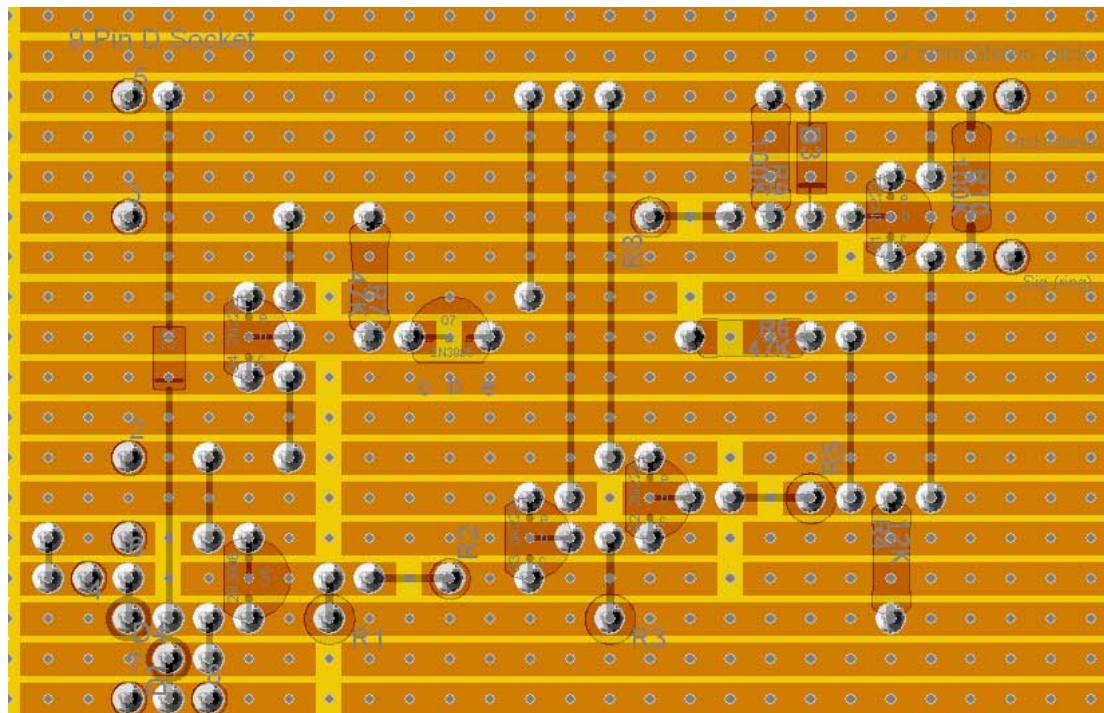

## Components list for VX-7R Interface

Q1	TO-18, 2N2222
Q2	TO-18, 2N2222
Q3	TO-18, 2N2222
Q4	TO-18, 2N2222
Q5	None!
Q6	TO-92, 2N3906
Q7	TO-92, 2N3906
D1	Si-diode, 1N914
D2	Zener-diode 500mW, 5.1V
D3	SI-diode, 1N914
D4	Si-diode, 1N914R8
R1	Resistor, 47K
R2	Resistor, 47k
R3	Resistor, 10K
R4	Resistor, 12K
R5	Resistor, 470K
R6	Resistor, 47K
R7	Resistor, 47K
R8	Resistor, 47K
R9	Resistor, 100K
R10	Resistor, 100K

There are ten jumpers to be positioned according to the matrix board layout.

If you source your 2N3906 from Maplin the pin out is not the TO-92 indicated but the TO-92b variant! Yes I had to revert to the transistor tester to find out!

## Construction

A few tips for those of you unfamiliar with matrix board.

- Mark out the size of board you require
- Score both sides of the board with a craft knife
- Snap to break to length
- Remove the rough edges with the knife or a file
- Before mounting any components clean the copper tracks with a BrilloPad and dry

The usual order of construction is to start with the lowest profile components and work systematically to those of the highest profile. I find it easier, when working with matrix board, to start from the left-hand side and work towards the right ignoring component size. This results in less hole counting. (Left-handers would reverse the direction).

A soldering iron tip of 2.5mm is ideal for this work.



The only specialist requirement for constructing with matrix board is a device for cutting the copper tracks. A spot face cutter is available from Maplin's, at a price. Fortunately there are many convenient alternatives. A drill bit set into a piece of dowelling makes a very effective tool as do some reamers – check your Swiss army knife. For a small project like this digging the track away with a craft knife is a practical alternative.

Once the board is complete and working the project needs to be boxed. A cheap light weight aluminium or plastic box is all that is required. In either case I find it easier to drill the necessary holes undersize and then open them up with a reamer. This results in a much neater hole for the grommet. If you have a set of chassis punches you have no need to read this! Pass the leads through the grommets and secure them with a few dabs of superglue. The board itself can be fixed by nuts and bolts, double sided adhesive foam pads or hot melt glue - just avoid shorts

Paste a scaled down circuit diagram in the lid of your box for future reference.

The only test equipment you should require is a multimeter to check resistance, voltages and continuity.

## **The Completed board**

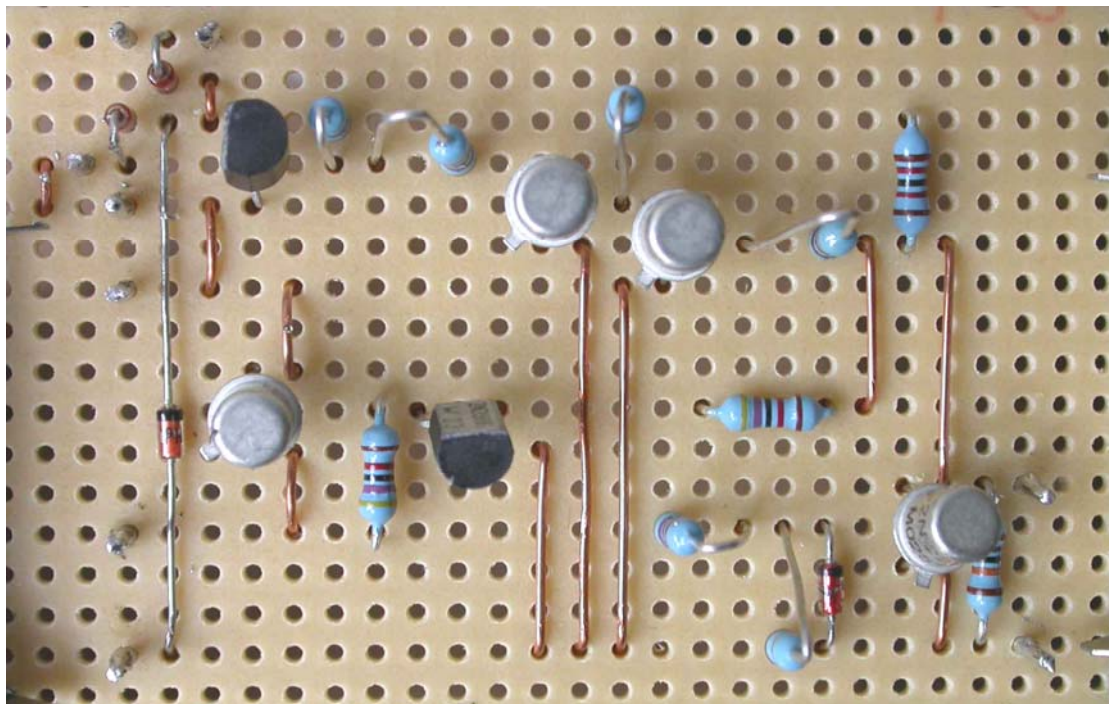

## Connections

### VX-7R

Connection to the computer is via a 9 D socket to the 9 pin D plug in the computer. The connection to the CT-91 is via a 2.5mm stereo jack plug with the signal line connected to the ring and ground to the barrel. The tip is not connected.

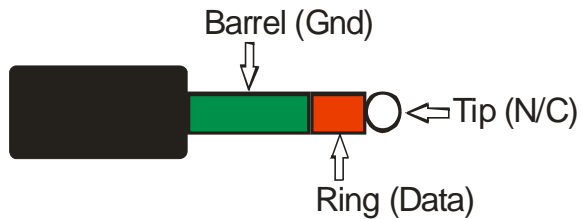

### VX-5R

The computer connection is as above. Connection to the rig is via a four section jack or via the CT-44 breakout lead using a 2.5mm mono jack with signal going to the sleeve and ground to the tip. (I have not tested this information).

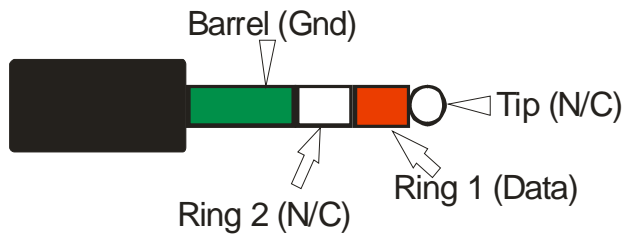

## The Completed Project



## Software

Jim Mitchell has provided us with two great programs for the VX-5R and VX-7R. In order to get the best from Jim's programs you need to follow, precisely, the sequence of rig button pushing instructions Jim recommends.

Join the VX-7R Yahoo group and download the Britain.vx7 file. Load this file into Commander select Advanced/Mods and tick "Enable software Mods". Once this has been done the essential next step is to read from your rig in order to synchronise it with the software. Having done this you can edit Britain.vx7 and transfer it to your rig. See below for a screen shot of the software.

### Commander with Britain.vx7 loaded.

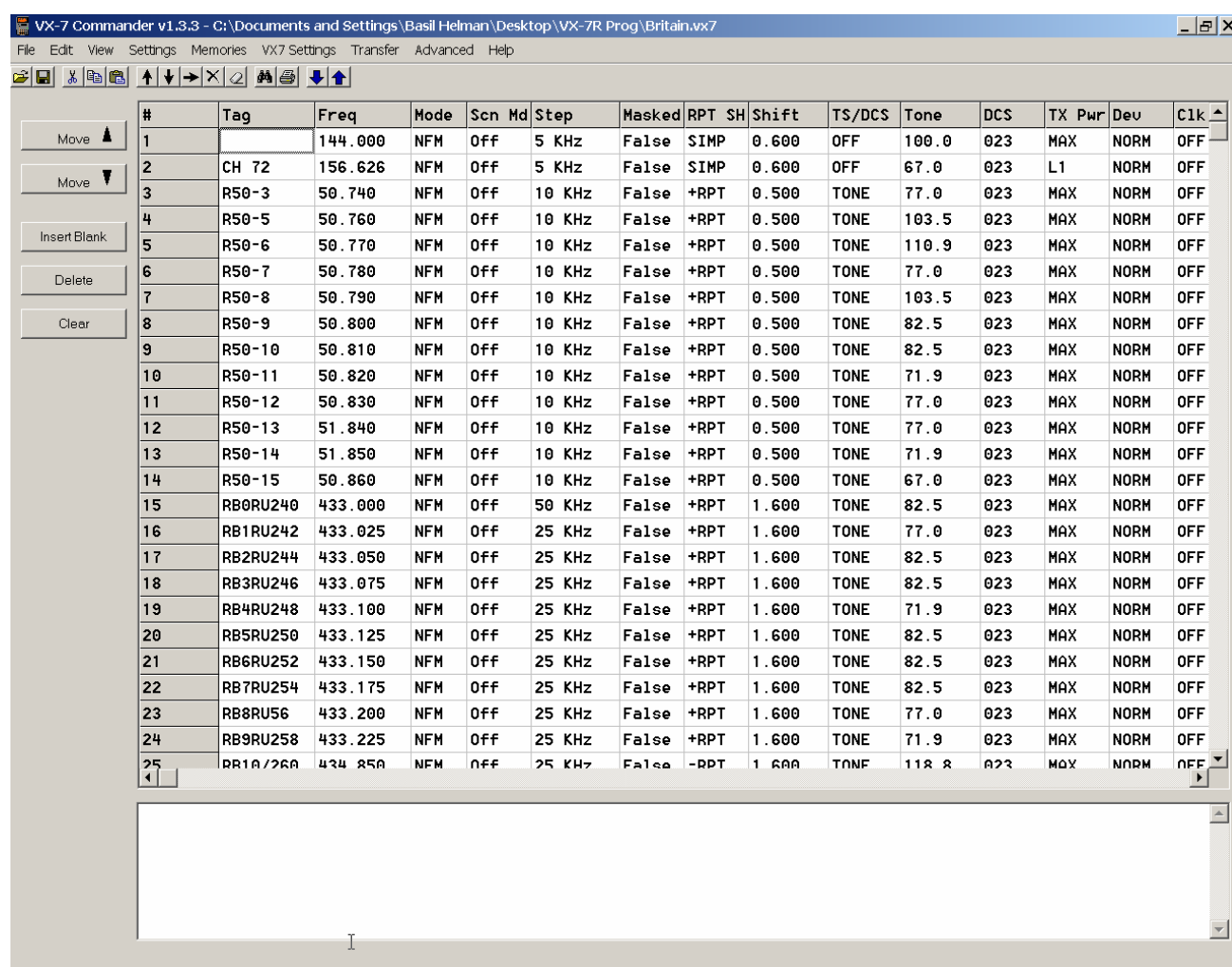

The screenshot shows the VX-7 Commander v1.3.3 software interface. The window title is "VX-7 Commander v1.3.3 - C:\Documents and Settings\Basil Helman\Desktop\VX-7R Prog\Britain.vx7". The menu bar includes File, Edit, View, Settings, Memories, VX7 Settings, Transfer, Advanced, and Help. The toolbar contains various icons for file operations and navigation. On the left side, there are buttons for "Move" (up and down arrows), "Insert Blank", "Delete", and "Clear". The main area is a table with the following columns: #, Tag, Freq, Mode, Scn Md, Step, Masked, RPT SH, Shift, TS/DCS, Tone, DCS, TX Pwr, Dev, and Clk. The table contains 25 rows of channel data.

#	Tag	Freq	Mode	Scn Md	Step	Masked	RPT SH	Shift	TS/DCS	Tone	DCS	TX Pwr	Dev	Clk
1		144.000	NFM	Off	5 KHz	False	SIMP	0.600	OFF	100.0	023	MAX	NORM	OFF
2	CH 72	156.626	NFM	Off	5 KHz	False	SIMP	0.600	OFF	67.0	023	L1	NORM	OFF
3	R50-3	50.740	NFM	Off	10 KHz	False	+RPT	0.500	TONE	77.0	023	MAX	NORM	OFF
4	R50-5	50.760	NFM	Off	10 KHz	False	+RPT	0.500	TONE	103.5	023	MAX	NORM	OFF
5	R50-6	50.770	NFM	Off	10 KHz	False	+RPT	0.500	TONE	110.9	023	MAX	NORM	OFF
6	R50-7	50.780	NFM	Off	10 KHz	False	+RPT	0.500	TONE	77.0	023	MAX	NORM	OFF
7	R50-8	50.790	NFM	Off	10 KHz	False	+RPT	0.500	TONE	103.5	023	MAX	NORM	OFF
8	R50-9	50.800	NFM	Off	10 KHz	False	+RPT	0.500	TONE	82.5	023	MAX	NORM	OFF
9	R50-10	50.810	NFM	Off	10 KHz	False	+RPT	0.500	TONE	82.5	023	MAX	NORM	OFF
10	R50-11	50.820	NFM	Off	10 KHz	False	+RPT	0.500	TONE	71.9	023	MAX	NORM	OFF
11	R50-12	50.830	NFM	Off	10 KHz	False	+RPT	0.500	TONE	77.0	023	MAX	NORM	OFF
12	R50-13	51.840	NFM	Off	10 KHz	False	+RPT	0.500	TONE	77.0	023	MAX	NORM	OFF
13	R50-14	51.850	NFM	Off	10 KHz	False	+RPT	0.500	TONE	71.9	023	MAX	NORM	OFF
14	R50-15	50.860	NFM	Off	10 KHz	False	+RPT	0.500	TONE	67.0	023	MAX	NORM	OFF
15	RB0RU240	433.000	NFM	Off	50 KHz	False	+RPT	1.600	TONE	82.5	023	MAX	NORM	OFF
16	RB1RU242	433.025	NFM	Off	25 KHz	False	+RPT	1.600	TONE	77.0	023	MAX	NORM	OFF
17	RB2RU244	433.050	NFM	Off	25 KHz	False	+RPT	1.600	TONE	82.5	023	MAX	NORM	OFF
18	RB3RU246	433.075	NFM	Off	25 KHz	False	+RPT	1.600	TONE	82.5	023	MAX	NORM	OFF
19	RB4RU248	433.100	NFM	Off	25 KHz	False	+RPT	1.600	TONE	71.9	023	MAX	NORM	OFF
20	RB5RU250	433.125	NFM	Off	25 KHz	False	+RPT	1.600	TONE	82.5	023	MAX	NORM	OFF
21	RB6RU252	433.150	NFM	Off	25 KHz	False	+RPT	1.600	TONE	82.5	023	MAX	NORM	OFF
22	RB7RU254	433.175	NFM	Off	25 KHz	False	+RPT	1.600	TONE	82.5	023	MAX	NORM	OFF
23	RB8RU256	433.200	NFM	Off	25 KHz	False	+RPT	1.600	TONE	77.0	023	MAX	NORM	OFF
24	RB9RU258	433.225	NFM	Off	25 KHz	False	+RPT	1.600	TONE	71.9	023	MAX	NORM	OFF
25	RB10/260	434.850	NFM	Off	25 KHz	False	+RPT	1.600	TONE	118.8	023	MAX	NORM	OFF

## Contact

If you have any comments or suggestions you can contact me by email at [basil.helman@bopenworld.com](mailto:basil.helman@bopenworld.com).

## Sources

Yahoo Groups – there are two of these one for each rig.

<http://groups.yahoo.com/group/YAESUVX7/>

<http://mywpages.comcast.net/sllewd/vx7rmain.htm>

<http://www.maplin.co.uk>

<http://mywpages.comcast.net/sllewd/>

<http://www.fairchildsemi.com/ds/2N/2N3906.pdf>